



EV CAR CHARGER

---

# ELECTRICAL INSTALLERS GUIDE

---

For models:

Single Phase 7.4kW 230V

VEVA TETHERED & VEVA UNTETHERED

Electric Vehicle Charge Points

# CONTENTS

This guide is intended for qualified electrical installers and provides information on the electrical installation of a VEVA charging unit and includes the following information...

1. Safety Information and advice
2. Description of the parts supplied
3. General Features of the unit
4. Wiring Diagram
5. Fixing and installation
6. How to wire the unit, supply requirements and connection
7. Earthing arrangements
8. Installing the measurement clamp
9. Commissioning and testing using the VEVA app.

## INSTALLATION FEATURES

Key installation features include...

- **Built in PEN fault detection**
  - Minimises the need for the installation of an Earth Rod
- **Built in 6mA DC fault protection and Type A RCD\***
- **Numerous cable entry possibilities**
  - Sides, bottom or rear of the unit
- **Inbuilt spirit level to aid alignment**
- **Solar charging and load balancing features**
  - Simple set up using the measurement clamp provided
- **Installation App to set up and configure the unit**
  - Free download
  - No account required
- **Simple connection to users Wi-Fi network**

\*see note page 8

## SAFETY ADVICE

- The electrical installation of this device must only be undertaken by a **suitably trained and qualified electrician**.
- All work must satisfy Building/IEE Wiring regulations in force at the time.
- Failure to comply with these installation instructions may result in damage to the unit and invalidate the warranty.

### Use of the equipment:

- This appliance may be used by children aged from 8 years and persons with reduced physical or sensory capabilities or lack of experience and knowledge, providing they have been given supervision or instruction concerning the use of the appliance in a safe way and understand the hazards involved.
- Children shall not play with the appliance.
- Cleaning or maintenance of the appliance shall not be performed by children.
- Do not use the unit if it appears broken, defective or otherwise damaged.
- Only use the unit as directed in this and the User Guide.
- Ensure the charging cable is stowed away and does not present a trip hazard.

## PARTS SUPPLIED

Before commencing any installation work, check you have received the following items:

1. VEVA charging unit
2. Measurement clamp with 8M cable
3. Cable Protector Plate and screws (prevents chafing of charging cable against a wall when stowing cable around unit)\*
4. Miniature junction box (to extend/join measurement clamp cable)
5. Wall fixings and screws (4 off)
6. Wall spacer kit (used when installing VEVA on an uneven wall) (3 kits)
7. Sealing washers (to be fitted under fixing screw head) (4 off)
8. Rubber bungs (to seal any unused fixing holes) (3 off)
9. Cable grommet (for rear cable entry)
10. Cable gland (for side or bottom cable entry)
11. Wall mounting template

\* Tethered units only

# GENERAL FEATURES

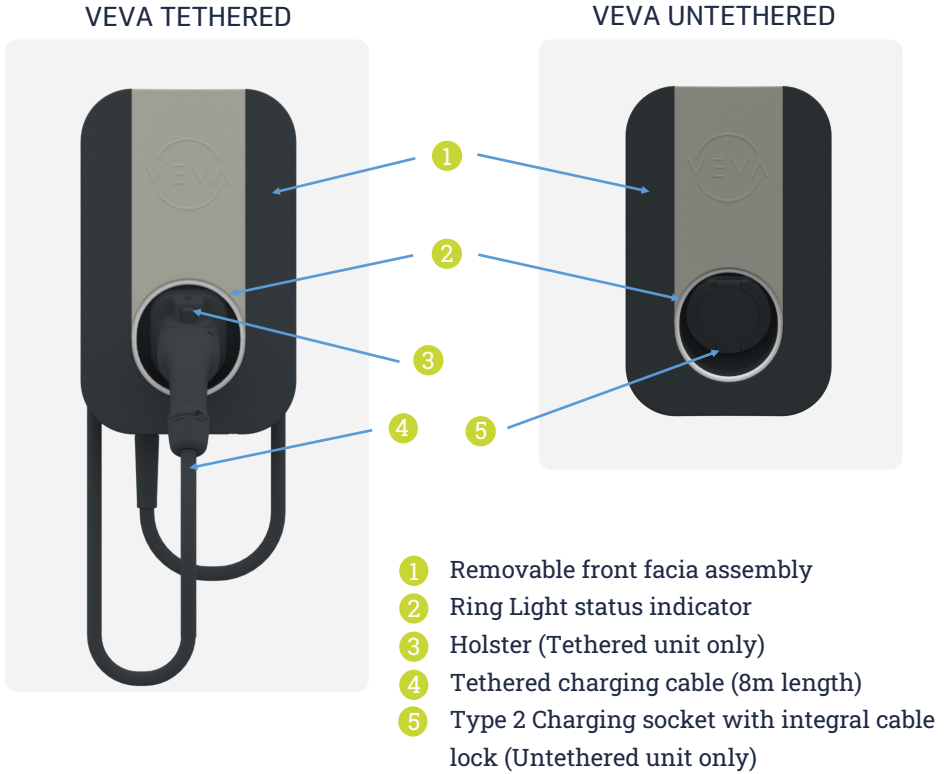

The VEVA charging unit is designed to allow a tethered charging cable to be wrapped around the body of the unit for cable stowage. When not in use, the cable should be coiled several times around the body, leaving sufficient cable to allow the charging connector to be plugged in and held by the holster within the ring light. The holster will protect the charging connector.

The charging connector is released by simply pressing the button at the top of the holster.

The cable should not be left trailing on the ground when not in use.

# WIRING DIAGRAM

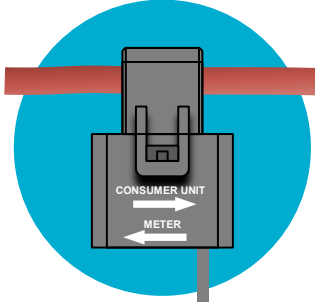
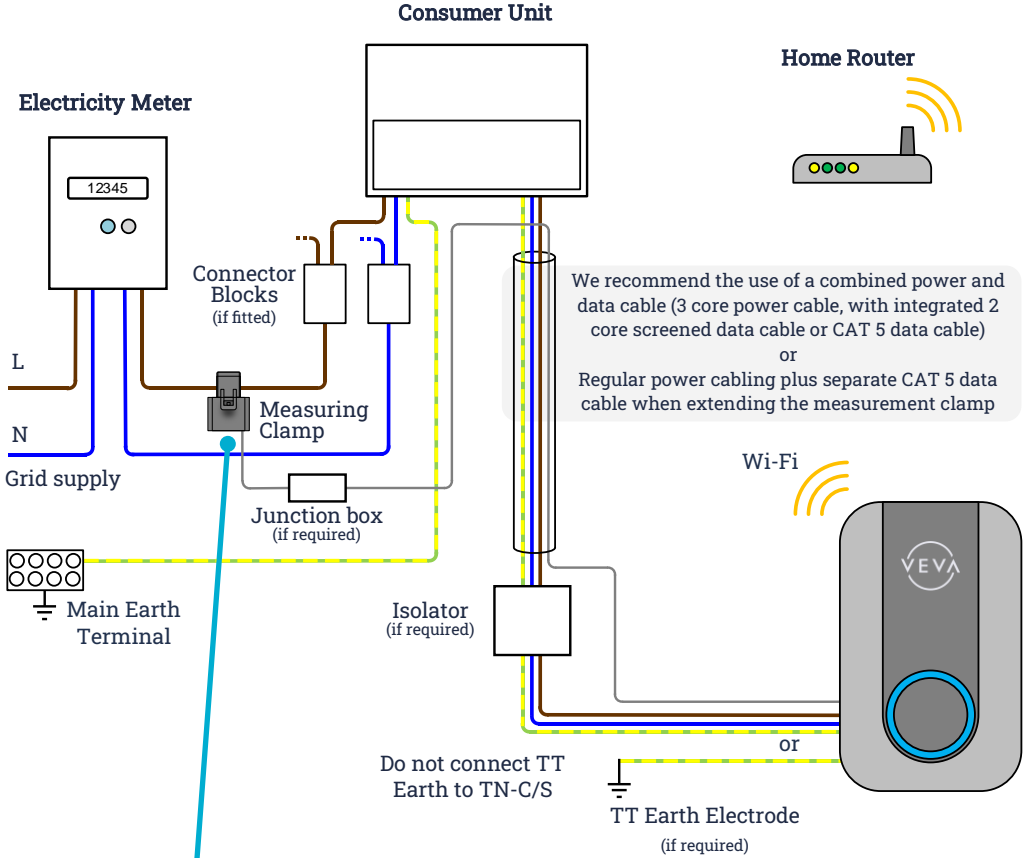

**Important - Observe markings to ensure correct orientation of measuring clamp on the live meter tail.**

**Install the measurement clamp between the main electricity meter and consumer unit (but before any connector blocks, if fitted).**

# INSTALLATION

**Locating the unit** - To operate fully, the VEVA must have a Wi-Fi connection. Before installing, check the chosen location has good signal strength to the users Wi-Fi network.

- Check for a Wi-Fi signal at the installation location using a mobile phone.
- If the network cannot be found, a suitable Wi-Fi extender must be installed.
- **The VEVA unit operates on 2.4GHz Wi-Fi networks only**

1. **Fit Cable Protector.** When installing a tethered unit against a rough wall, fit the Cable Protector Plate. The plate helps prevent chafing of the charging cable against the wall when stowing around the unit. The plate may also be used to aid cable stowage when using a mounting post. Screw the plate to the rear of the unit using the screws provided.



2. **Remove the front fascia.** Loosen the two screws fitted along the bottom edge of the fascia ① (no need to remove) and lift the cover away from the base ②. Remove cover by pulling upwards and unhooking at the top edge ③.

3. **Remove Front Cover.** Unscrew the seven fixings from the enclosure (these are captive in the cover and should remain fitted). Carefully lift the Front Cover away from the base.



4. Install cable entry. Select one of the six possible cable entry locations shown opposite.

- When cable entry is from the back of the unit, use the cable grommet supplied (not the gland).
- Cut a 25mm hole to fit either the cable gland or grommet.
- Take care to ensure that the weatherproof rating of the unit is maintained during this step.
- Cable entry at any other location than those shown is prohibited.



5. Fix the unit to the wall.

- For wall mounting - use the top fixing hole together with right and left lower holes. For post mounting - use the top hole and two centre vertical holes (undrilled).
- To fix, it is recommended that the top fixing hole is marked, drilled and the unit screwed loosely to the wall. Using the built-in spirit level, align the unit vertically and mark the two remaining fixing holes. Rotate the unit to the left and right around the top fixing point to allow the drilling of the fixing holes.
  - \* Alternatively, use the wall fixing template provided.When drilling, ensure dust is prevented from entering the unit.
- Ensure the base is not distorted after fixing. If fitting against an uneven wall, the unit may be levelled using the round spacers (supplied). Reduce any gaps by fitting spacers over the fixing lugs in the base as required.
- When screwing to the wall, always fit the sealing washers (supplied) below the screw head to maintain weatherproofing integrity.
- Any unused fixing holes **must** be sealed with bungs (supplied).

6. Wire the unit as per page 8, 9 and 10.

7. Refit Front Cover. Check the Main Seal is undisturbed and firmly in place, then refit the front cover. Secure the cover with the captive screws ensuring each screw is still fitted with a seal. Take care not to distort the cover when refitting, tighten each screw a little, in turn. Do not use a power driver. Screws must not be tightened over 1 Nm.

8. Commission and test the unit as per the later sections. Replace the front fascia.

# WIRING THE UNIT

## SUPPLY

The VEVA unit should be connected to a 230V nominal AC supply using a cable with a conductor CSA suitable for the installation run, and selected according to the current wiring regulations.

The supply should be run from a dedicated 32A\*<sup>1</sup> circuit breaker to provide isolation and overcurrent protection. It is recommended that Curve C circuit breakers are used. An RCBO with equivalent rating and characteristics may be used.

\*<sup>1</sup> The unit may alternatively be supplied from a 16A circuit breaker, however the unit must be downrated to 16A maximum output using the Engineering function of the VEVA app, see page 13.

The unit has inbuilt 6mA DC fault protection and a 30mA Type-A RCD \*<sup>2</sup>.

\*<sup>2</sup> Although the unit has inbuilt RCD protection, to meet current wiring regulations the fitting of an additional external 30mA Type-A RCD is also required.

Further isolation of the supply to the VEVA unit may need to be provided. An isolator switch is mandatory for new builds but can be installed at the customer's request for existing dwellings.

All installations must be compliant to BS7671:2018.

## CONNECTION

Insert the supply cable through the installed cable gland or grommet and ensure that the cable has sufficient length to reach the terminal blocks.

All cables that are connected to the supply terminals shall have their insulation stripped back 8 to 12mm.

When connecting the VEVA unit, the supply terminal block is clearly labelled Live, Neutral and earth. Connect as shown opposite. Recommended tightening torque of supply terminals is 1.5 Nm.

It is recommended to use a combined power and data cable designed for the connection of EV chargers. Further information on the connection of the measurement clamp is provided in the next section.

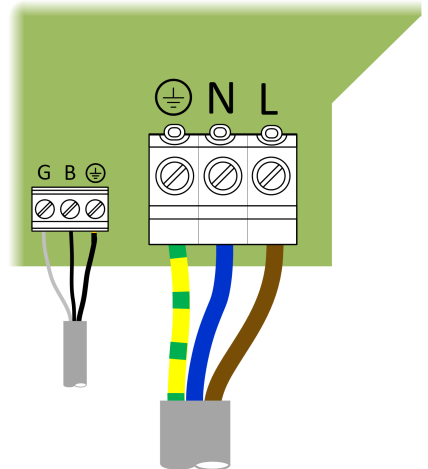



## EARTHING ARRANGEMENTS

The VEVA unit features on-board safety monitoring to provide protection to the user against electric shock in the event that the PEN conductor becomes damaged or disconnected. The unit continuously monitors the incoming supply to detect problems with the PEN conductor, and if so, automatically disconnects the supply to the output of the charger. The vehicle becomes isolated from the charger meaning there is no risk of electric shock.

## EARTH RODS

The VEVA unit is compliant with regulation 722.411.4.1(v) of BS7671:2018-amd1: 2020 meaning **when directly connected to a TN-C-S (PME) earthing system, an earth electrode is not required.**

Where certain conditions dictate that an earth electrode must be used e.g., the installation is part of a TT earthed system, it shall be independent from the distributors earth system. The earth connection shall be made via copper conductor earth wire of an appropriate CSA for the installation. It is recommended that the distributors earth system is terminated at the input to the charge point to provide further protection against mechanical damage to the incoming supply cable. It remains the responsibility of the installer to conduct a risk assessment of the immediate area to ensure no buried objects pose risks to the earth electrode.

# INSTALLING THE MEASUREMENT CLAMP

The measurement clamp must be fitted if Charging by Solar or the dynamic Demand Control functions are to be used.

The measurement clamp is a sensor used to monitor the current flowing to, or from, the grid. The clamp is installed around the live meter tail between the main electricity meter and consumer unit.

1. Identify clamp fitting position. The clamp must be fitted on the live cable between the main electricity meter and the consumer unit. If the live supply has been split with a connector block, the clamp should be fitted between the meter and block.

2. Wire the clamp to the VEVA unit. The measurement clamp is supplied with an 8m cable with Grey and Black conductors. Depending on clamp version, a third shield wire may also be provided. Install the cable then connect the conductors to the small terminal block (Grey to G, Black to B), as shown. If provided, connect the shield wire to the earth terminal.

If the cable needs to be extended, or if using the data cable within a combined data and power supply cable, shorten the clamp cable and connect to the data cable using the miniature junction box (supplied).

**Note: To prevent interference, any additional cable used must be either twisted pair or shielded, twisted pair cable e.g., CAT 5 data cable. Failure to use a correct data cable will cause distortion to measurements.**

Where using a shielded data cable, the cable shielding must be connected to the earth terminal of the VEVA connector block. It is good practice to protect the exposed copper shield with a small length of sleeve.

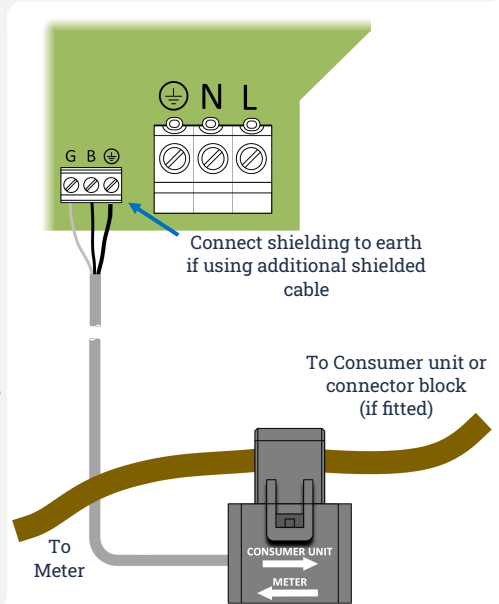

3. Install clamp. Open the measurement clamp and position around the previously identified supply cable, observing the correct orientation marked on the clamp. Close the clamp around the cable and ensure that the latch is engaged.

The commissioning process will check that the clamp has been fitted correctly. If the clamp has the wrong orientation, this can be corrected automatically without needing to change the installation using the Engineering function of the VEVA app, see page 13.

**Warning: Do not fit the clamp around supply cable before wiring to the terminal block. High voltage can be generated across unterminated clamp conductors.**

# COMMISSIONING AND TESTING

**Before commissioning, the installer must carry out sufficient checks to ensure the installation is compliant with the requirements of BS7671: 2018.**

## COMMISSIONING PROCESS

To commission the VEVA unit, you will need to download the VEVA app...



1. Search for VEVA in the App Store or on Google Play and install the app onto your smartphone



There is no need to create an account.

2. Using the Engineers commissioning section of the App (see below), connect to a Wi-Fi hotspot created by the VEVA unit, after pressing the pairing button

3. Configure the installation settings

4. Test and check the VEVA unit is operational and running correctly

5. Connect the VEVA unit to the homeowners Wi-Fi network (this can be skipped if the home is a new-build or if the homeowner prefers to do this themselves)

The process is detailed in the following sections...

**Electric Vehicles (Smart Charge Points) Regulations** - At the point of sale, the charge point is set to charge only during off-peak hours. To commission the charger, settings can be briefly overridden whilst the charger is in installation mode, allowing sufficient time to perform the required functionality tests described below.

## 1. USING THE VEVA APP

When first using the app, it may request you to accept Location Services. Accept the request as this may help when connecting the unit to the homeowners Wi-Fi later. Additionally, if using an Apple smartphone, if possible, connect your device to the homeowners Wi-Fi network. Again, this will help if connecting the VEVA unit to Wi-Fi later. However, ensure the network is a 2.4GHz Wi-Fi network (the VEVA unit will only connect to 2.4GHz networks). If in doubt do not connect to the Wi-Fi.

To use the commissioning tool, go to the 'Get Started' page and select the Engineers Section as shown highlighted, right.

- There is no need to create an account; a login name or password is not required.
- The App will guide you through the process.

Move through the pages until you are asked 'Connect to your charge point first', then follow the next pages.

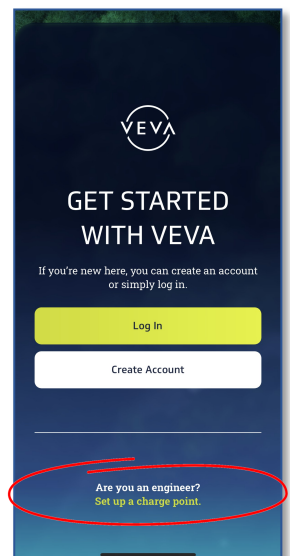

## 2. CONNECTING TO THE VEVA UNIT

The commissioning process is carried out by connecting your mobile device to a Wi-Fi hotspot created by the VEVA unit. Connection is simple as follows...

### 1. Push the Wi-Fi Access Point button.

With the front fascia removed, power up the unit.

Push down on the Wi-Fi Access Point button and hold for **two seconds**. The ring light will change colour to yellow to indicate the unit has entered installation mode.

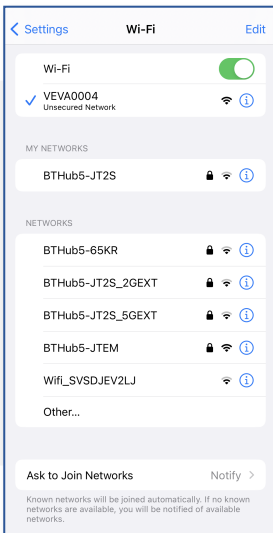
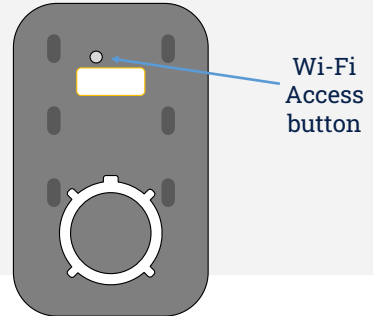

### 2. Connect to the VEVA Hotspot.

The VEVA unit will create its own temporary Wi-Fi hotspot named VEVA, plus the last 4 digits of the serial number.

Leave the VEVA App and go to the Wi-Fi Settings page of your smartphone and select the VEVA hotspot from the list of networks found. Your smartphone will connect to the unit's Wi-Fi hotspot.

Return to the VEVA App.

### 3. Connected.

When returning to the VEVA App, it will automatically connect to the VEVA unit and confirm on the screen.

If the App does not connect, return to the home screen and retry the process. Try turning off mobile data or disable Wi-Fi assist.

Select 'Go to charge point settings' and continue to the next section.

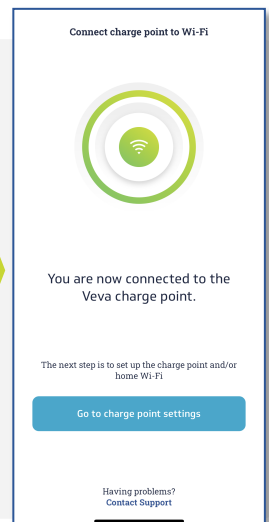
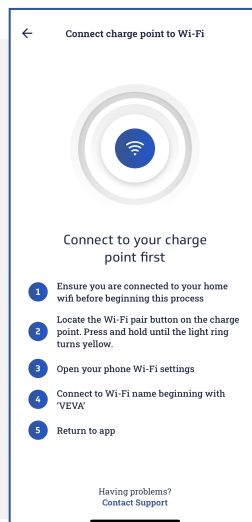

## 3. SET UP AND ELECTRICAL TESTING

Using the Charger Settings page, set up and test the following...

### 3. Configure settings for the installed unit:

- **Current measuring clamp fitted** – Select whether a measurement clamp has been fitted, yes/no.
- **Demand Control Supply rating** – Enter the properties fuse rating (only applicable if a clamp is fitted).
- **Charge point maximum output current** – Configure the maximum output of the charge point (16 or 32A), depending on the rating of the supply circuit.
- **Earth rod fitted** – Select if an earth rod was required for the installation, yes/no.

### 4. Check measurement clamp is reading correctly, if fitted:

Using the **Total Household Current** value, ensure the measurement clamp is fitted in the correct orientation and the reading is stable (-ve value means current is measured as exporting to the grid). If required, the value can be inverted using the **Invert measurement clamp value** selection (saves refitting the clamp).

If the reading is unstable, too high or too low, this could be the result of the wrong cable being used to extend the clamp cable, poor cable shielding or not connecting a shield to earth at the VEVA unit.

Solar Systems - Ensure the direction of current flow is as expected. Try switching on a high power device and checking flow direction, if possible charge an EV. Battery storage systems attempt to zero current drawn from the grid and may cause reading confusion.

### 5. Check Supply Voltage.

Check the **Supply Voltage** value and ensure the value is within 230V AC  $\pm$  10%. If not, an earth rod may be required (and configured as installed in the above settings) to allow the voltage limits to be raised to 230V +12% / -10%. If the voltage is still outside of the limits, the local Distribution Company (DNO) may be required to resolve the issue. Overvoltage will cause nuisance fault tripping of the charge point.

## 4. FUNCTIONAL TESTING

For functional testing, pressing the **Activate 30-min Boost button** will enable charging:

- Confirm charge point operation with EVSE test adapter
- Confirm the operation of the RCDs is within stipulated timescales
- Verify charging operation with customers vehicle
- If connecting a car, check **Charge point Current** to ensure charging is at correct rate.

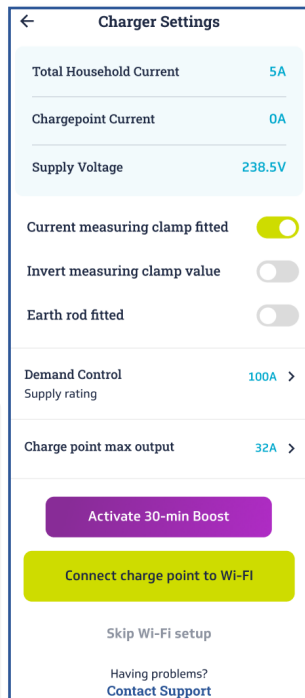

## 5. Wi-Fi SET UP

After all tests are completed, the VEVA unit may be connected to the homeowners Wi-Fi network. From the Charger Settings page, select “Connect charge point to Wi-Fi” to continue with Wi-Fi set up or “Skip Wi-Fi setup” if you are unable to do so at this point. To set up a Wi-Fi connection follow as below...

1. Select the Wi-Fi network and add password, the VEVA unit should connect to and operate on:

Android devices – See right, select the desired network from the list of networks found. Enter the Wi-Fi password at the next page.

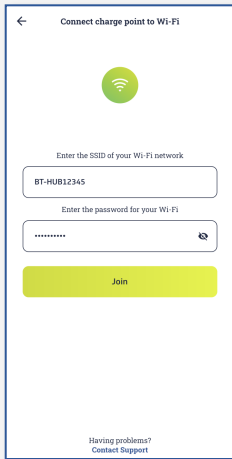

Apple iOS devices – Privacy rules prevent a list of networks being shown. However, if Location Services have been accepted (when first using the App) and the smartphone is connected to the homeowners Wi-Fi network, the App will automatically suggest the Wi-Fi network you were connected to and just require the password.

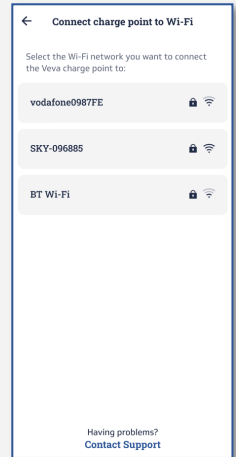

If a network is not suggested, type in the SSID of the network to be used, together with password, see left.

Press **Join** and the VEVA unit will attempt to join to the Wi-Fi network selected.

2. Check that the VEVA unit has successfully joined the network.

The ring light will indicate whether the unit has successfully joined the network (the right half of the ring indicates Wi-Fi connection, the left half indicates connection to the VEVA cloud). Check the final colour as follows:

### All Green

The unit has successfully connected to the Wi-Fi network and can communicate with the VEVA cloud. Installation is fully complete.

### All Red

The unit has not connected. This could be :

- An incorrect password or SSID name was used (both halves Red);
- Insufficient Wi-Fi signal strength at the VEVA unit (both halves Red), a Wi-Fi extender may be required in this case;
- No internet connection and the unit cannot communicate with the VEVA cloud (initially right half of ring shown Green, before fully turning Red). This indicates Wi-Fi has connected but no internet);

Check the internet connection and retry the Wi-Fi set up.

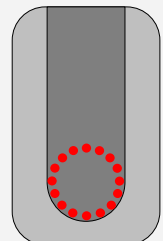
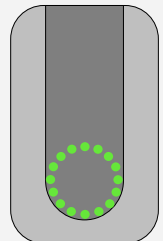

# TECHNICAL SPECIFICATIONS

## PRODUCT INFORMATION

CHARGING CONNECTOR (DEPENDANT ON MODEL):

VEVA TETHERED: Type 2 Tethered Cable (8 metre length)

VEVA UNTETHERED: Type 2 Socket with lock

CHARGING PROTOCOL:

Mode 3 Charging (according to IEC 61851-1)

MOUNTING TYPE / LOCATION:

Indoor or Outdoor (permanent mounting)

CHARGING CURRENT

Variable 6A – 32A

CHARGING PROFILES

Anytime Charge, Scheduled Charge and Solar Charge\*

LOAD BALANCING

Current limiting to protect property fuse. Max 100A\*

\*Measurement Clamp must be installed for functions to operate, clamp supplied

COMMUNICATION

Wi-Fi 802.11 b/g/n @2.4 GHz

CHARGING STATUS INDICATION

Multi-colour LED ring light

COMPLIANCE

UKCA Compliant: The Electrical Equipment Safety Regulations 2016, The Electromagnetic Compatibility Regulations 2016, The Restriction of the Use of Hazardous Substances in Electrical and Electronic Equipment Regulations 2012, The Radio Equipment Regulations 2017.

CE Compliant to the following EU Directives: LVD, EMC, ROHS, RED

Conforms to standards: EN IEC 61851-1, EN IEC 61851-21-2, EN 300328, EN 301489-1/3/17/52, EN 301908-1, EN 301511, IEC 62955 clauses 9.3-9.11, 9.13-9.14, 9.18-9.20, 9.22

## ELECTRICAL SPECIFICATIONS

RATED SUPPLY VOLTAGE: 230V AC Single Phase (+/-10%)

RATED CURRENT: 32A max

RATED POWER: 7.4 kW

GRID FREQUENCY: 50 Hz

EARTH LEAKAGE PROTECTION: Inbuilt Type A RCD and 6mA DC protection

CABLE ENTRY: Rear, side or bottom

STANDBY POWER CONSUMPTION: 3W

## MECHANICAL SPECIFICATIONS

INGRESS PROTECTION : IP65

OPERATING TEMPERATURE: -25°C to +40°C

ENCLOSURE MATERIAL: PC ABS / ASA

ENCLOSURE DIMENSIONS: 240 x 386 x 129mm

IMPACT RATING: IK08



If there's anything you'd like help with or to send us feedback on how to improve our services and devices, please don't hesitate to contact us:

[support@vevacharger.com](mailto:support@vevacharger.com)

tel: 01536 447861

[www.vevacharger.com](http://www.vevacharger.com)

Powered by

The Marlec logo consists of a stylized sunburst or flower-like symbol made of several white, pointed petals radiating from a central point.  
**marlec**  
renewable power